

Buck chopper MOSFET Power Module

$V_{DSS} = 500V$
 $R_{DSon} = 17m\Omega \text{ typ @ } T_j = 25^\circ C$
 $I_D = 180A \text{ @ } T_c = 25^\circ C$

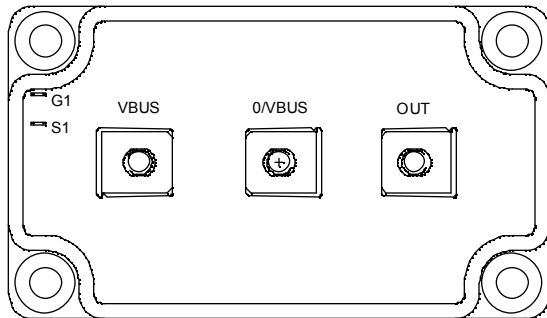
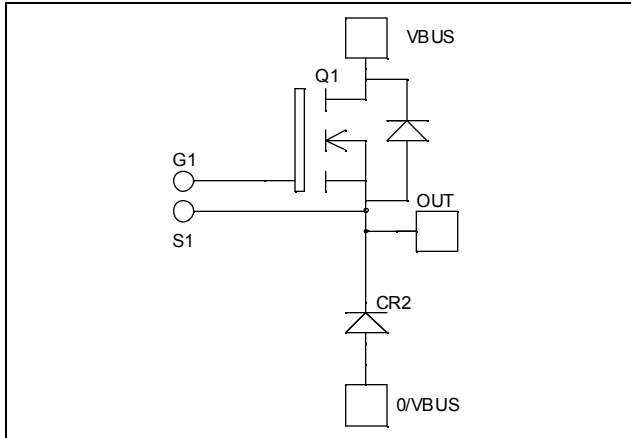

Application

- AC and DC motor control
- Switched Mode Power Supplies

Features

- Power MOS 7[®] MOSFETs
 - Low R_{DSon}
 - Low input and Miller capacitance
 - Low gate charge
 - Avalanche energy rated
 - Very rugged
- Kelvin source for easy drive
- Very low stray inductance
 - Symmetrical design
 - M5 power connectors
- High level of integration

Benefits

- Outstanding performance at high frequency operation
- Direct mounting to heatsink (isolated package)
- Low junction to case thermal resistance
- Low profile
- RoHS Compliant

Absolute maximum ratings

Symbol	Parameter	Max ratings	Unit
V_{DSS}	Drain - Source Breakdown Voltage	500	V
I_D	Continuous Drain Current	$T_c = 25^\circ C$	180
		$T_c = 80^\circ C$	135
I_{DM}	Pulsed Drain current	720	A
V_{GS}	Gate - Source Voltage	± 30	V
R_{DSon}	Drain - Source ON Resistance	20	$m\Omega$
P_D	Maximum Power Dissipation	$T_c = 25^\circ C$	1250
I_{AR}	Avalanche current (repetitive and non repetitive)	51	A
E_{AR}	Repetitive Avalanche Energy	50	mJ
E_{AS}	Single Pulse Avalanche Energy	3000	

CAUTION: These Devices are sensitive to Electrostatic Discharge. Proper Handling Procedures Should Be Followed. See application note APT0502 on www.microsemi.com

All ratings @ $T_j = 25^\circ\text{C}$ unless otherwise specified

Electrical Characteristics

Symbol	Characteristic	Test Conditions	Min	Typ	Max	Unit
I_{DSS}	Zero Gate Voltage Drain Current	$V_{GS} = 0\text{V}, V_{DS} = 500\text{V}$			400	μA
		$V_{GS} = 0\text{V}, V_{DS} = 400\text{V}$			2000	
$R_{DS(on)}$	Drain – Source on Resistance	$V_{GS} = 10\text{V}, I_D = 90\text{A}$		17	20	$\text{m}\Omega$
$V_{GS(th)}$	Gate Threshold Voltage	$V_{GS} = V_{DS}, I_D = 10\text{mA}$	3		5	V
I_{GSS}	Gate – Source Leakage Current	$V_{GS} = \pm 30\text{V}, V_{DS} = 0\text{V}$			± 200	nA

Dynamic Characteristics

Symbol	Characteristic	Test Conditions	Min	Typ	Max	Unit
C_{iss}	Input Capacitance	$V_{GS} = 0\text{V}$		28		nF
C_{oss}	Output Capacitance	$V_{DS} = 25\text{V}$		5.6		
C_{rss}	Reverse Transfer Capacitance	$f = 1\text{MHz}$		0.36		
Q_g	Total gate Charge	$V_{GS} = 10\text{V}$		560		nC
Q_{gs}	Gate – Source Charge	$V_{Bus} = 250\text{V}$		160		
Q_{gd}	Gate – Drain Charge	$I_D = 180\text{A}$		280		
$T_{d(on)}$	Turn-on Delay Time	Inductive switching @ 125°C $V_{GS} = 15\text{V}$ $V_{Bus} = 333\text{V}$ $I_D = 180\text{A}$ $R_G = 0.5\Omega$		21		ns
T_r	Rise Time			38		
$T_{d(off)}$	Turn-off Delay Time			75		
T_f	Fall Time			93		
E_{on}	Turn-on Switching Energy	Inductive switching @ 25°C $V_{GS} = 15\text{V}, V_{Bus} = 333\text{V}$ $I_D = 180\text{A}, R_G = 0.5\Omega$		4140		μJ
E_{off}	Turn-off Switching Energy			3380		
E_{on}	Turn-on Switching Energy	Inductive switching @ 125°C $V_{GS} = 15\text{V}, V_{Bus} = 333\text{V}$ $I_D = 180\text{A}, R_G = 0.5\Omega$		6224		μJ
E_{off}	Turn-off Switching Energy			4052		

Chopper diode ratings and characteristics

Symbol	Characteristic	Test Conditions	Min	Typ	Max	Unit
V_{RRM}	Maximum Peak Repetitive Reverse Voltage		600			V
I_{RM}	Maximum Reverse Leakage Current	$V_R = 600\text{V}$	$T_j = 25^\circ\text{C}$		500	μA
			$T_j = 125^\circ\text{C}$		1000	
I_F	DC Forward Current			180		A
V_F	Diode Forward Voltage	$I_F = 180\text{A}$		1.6	1.8	V
		$I_F = 360\text{A}$		1.9		
		$I_F = 180\text{A}$	$T_j = 125^\circ\text{C}$		1.4	
t_{rr}	Reverse Recovery Time	$I_F = 180\text{A}$ $V_R = 400\text{V}$ $di/dt = 600\text{A}/\mu\text{s}$	$T_j = 25^\circ\text{C}$		130	ns
			$T_j = 125^\circ\text{C}$		170	
Q_{rr}	Reverse Recovery Charge	$I_F = 180\text{A}$ $V_R = 400\text{V}$ $di/dt = 600\text{A}/\mu\text{s}$	$T_j = 25^\circ\text{C}$		660	nC
			$T_j = 125^\circ\text{C}$		2760	

Typical Performance Curve

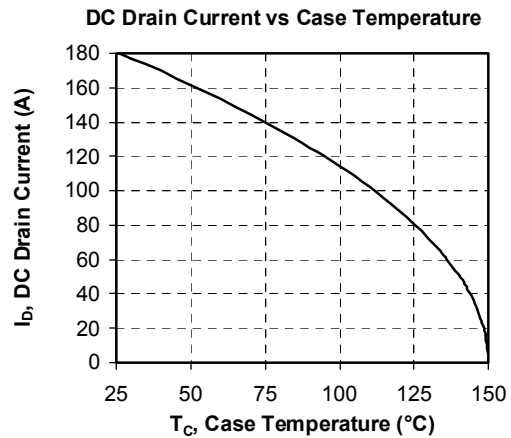
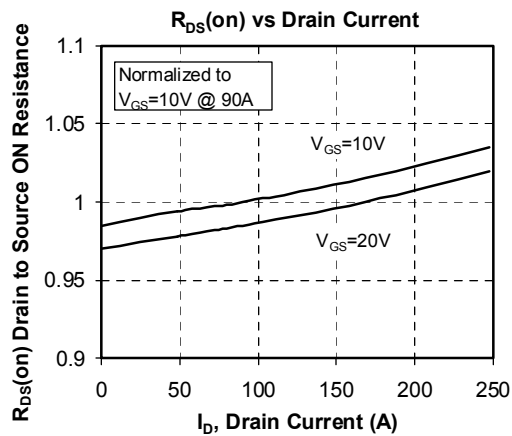
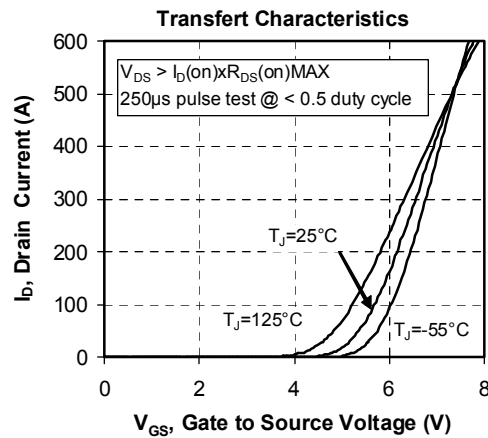
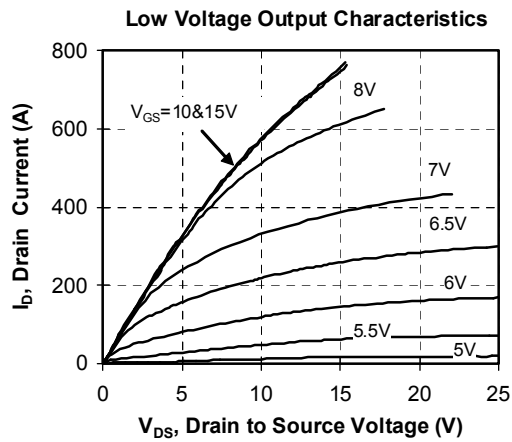
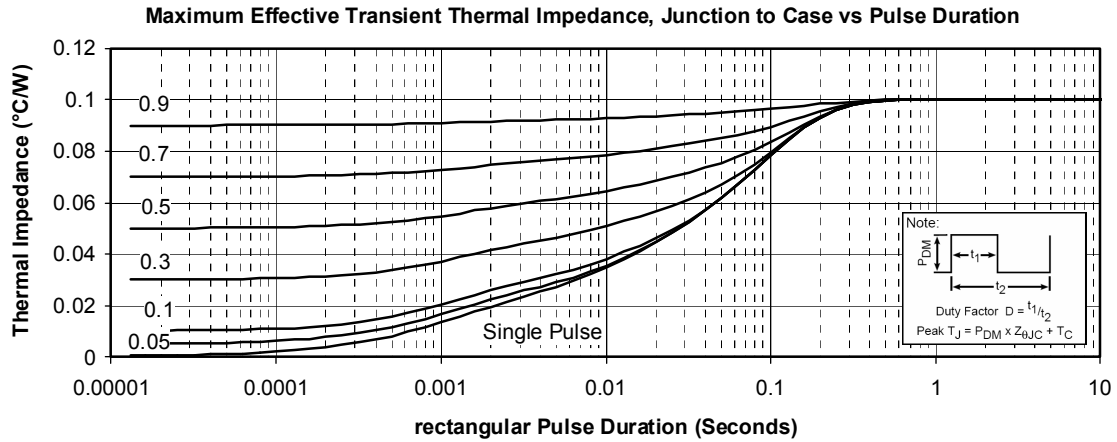

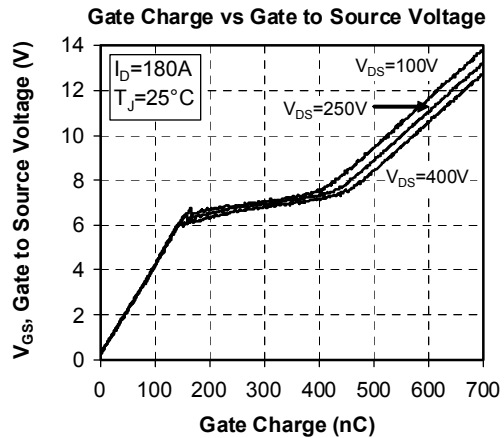
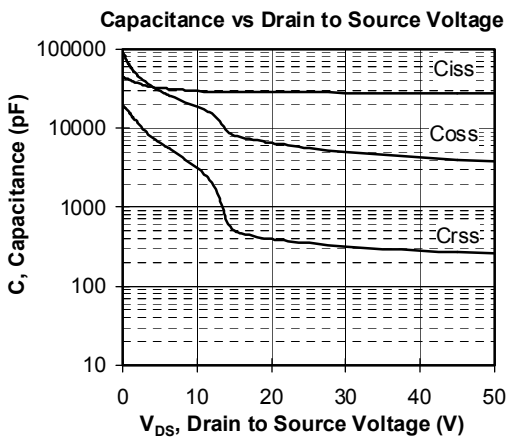
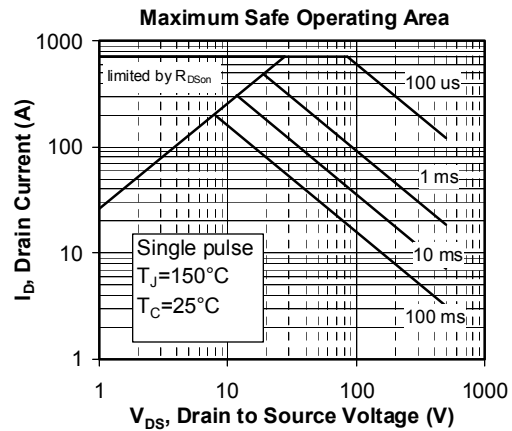
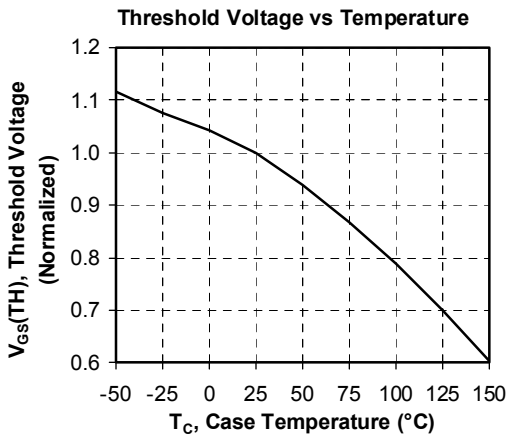
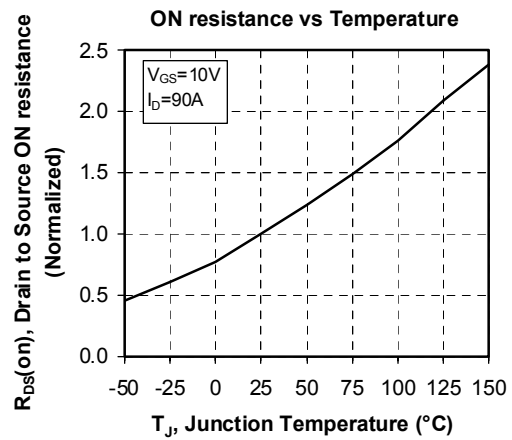
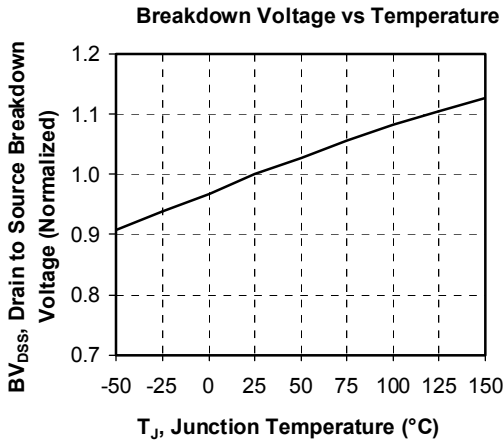

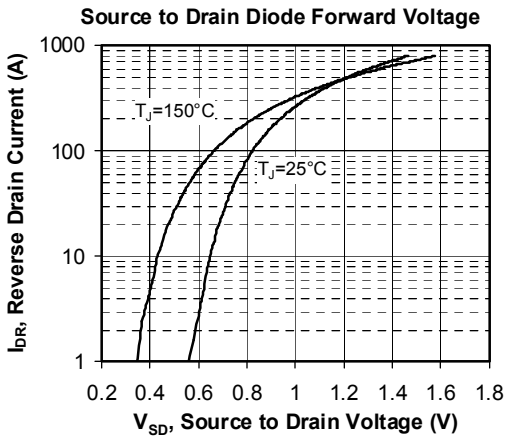
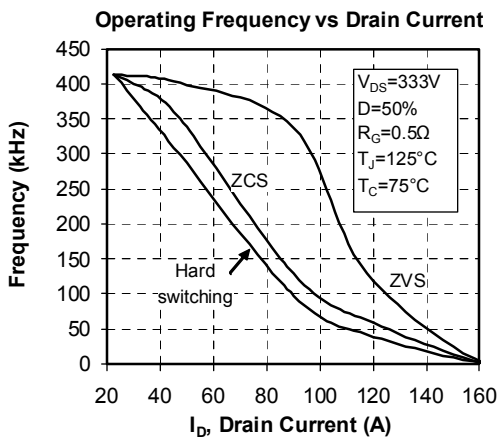
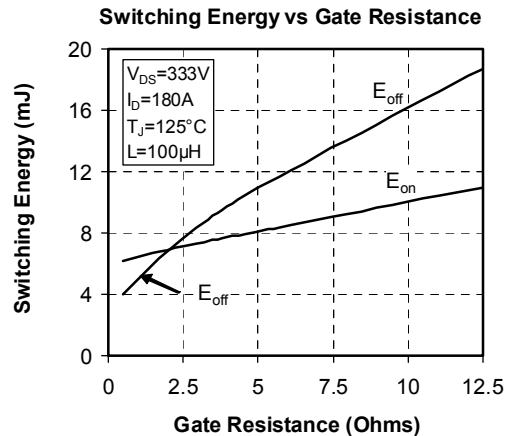
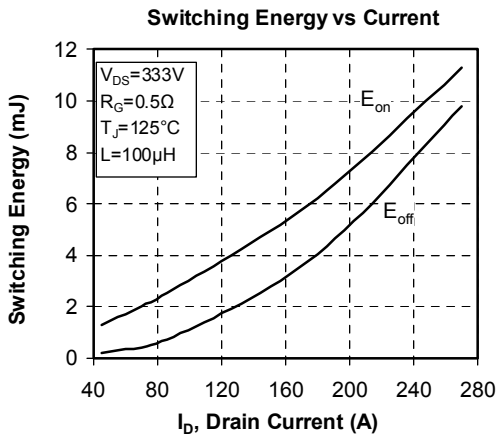
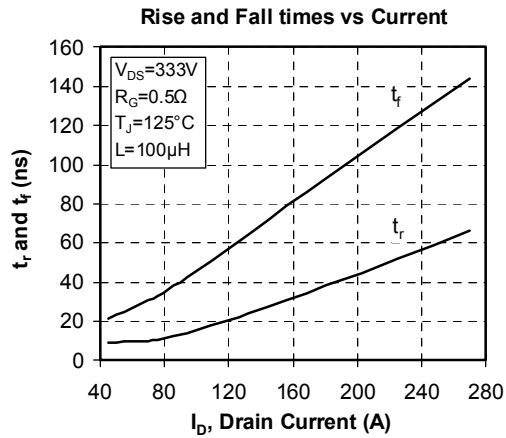
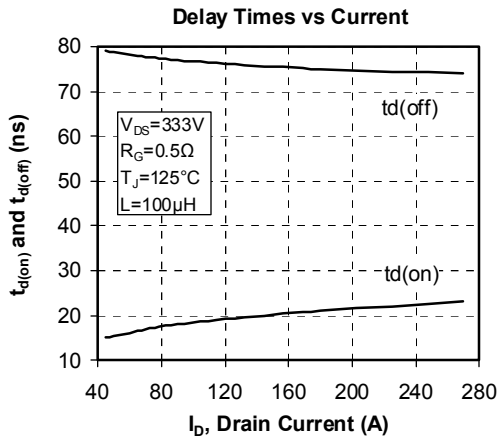

Microsemi reserves the right to change, without notice, the specifications and information contained herein

Microsemi's products are covered by one or more of U.S. patents 4,895,810 5,045,903 5,089,434 5,182,234 5,019,522 5,262,336 6,503,786 5,256,583 4,748,103 5,283,202 5,231,474 5,434,095 5,528,058 and foreign patents. U.S. and Foreign patents pending. All Rights Reserved.

